

ALUMINUM FRAME
SIZE AND DRAINS
(OUTSIDE VIEW)

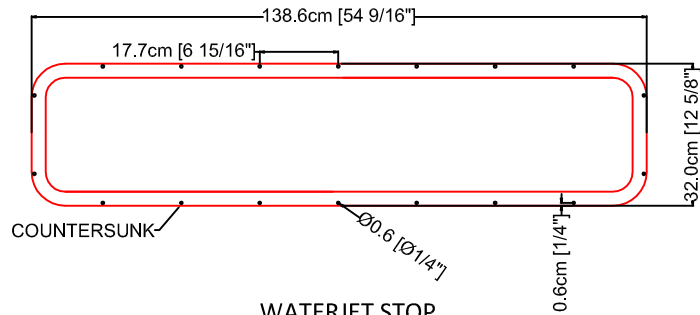

WATERJET STOP
(AS VIEWED FROM INSIDE)

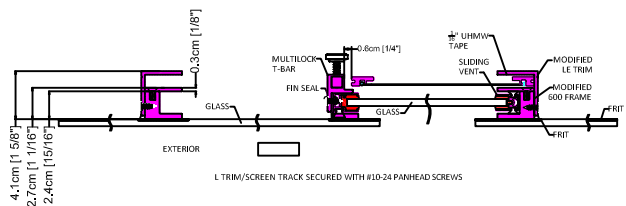
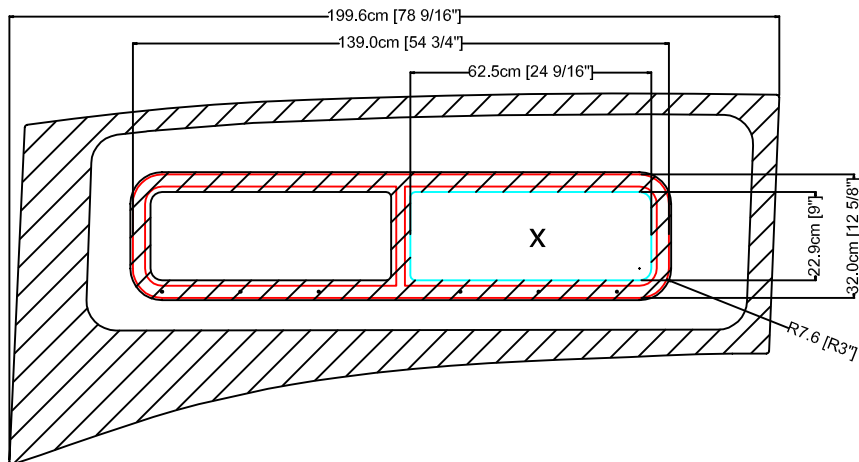

CUSTOMER:	YCSYACHT
CUSTOMER PART NO:	
TYPE:	Cust-Win
CORNERS:	
GLASS:	
FINISH:	
BOLT HOLES:	
TRIM TYPE:	
BLOCK SIZE:	77 X 34

CUSTOM NOTES:

Glass in Glass Slider Bonded Aluminum Slider
6mm 45% Grey Tempered Fritted Glass
Slides FWD to AFT
C/W Sliding Screen
Frit as per pattern, no dot matrix required
No finish on glass edge
PC Jet black on slider frame
3" radius corner on slider frame

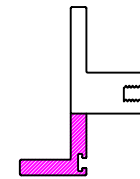
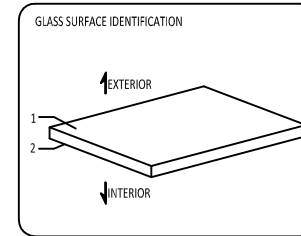
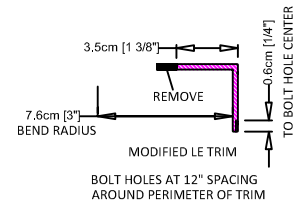

MODIFIED 600 FRAME

1- None

2- Frit

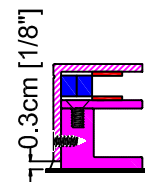

Modified LE Trim Calcs
76.4 - 90.0
105.0 - 90.0
182.3 - Cut Length
x 2
+ 10 Add On

Screen Calcs
64.7 - 90.0
90.5 - 90.0
155.2 - Cut Length
T-Bar
1 @ 29.5 90/90

Vent Calcs
65.0 - 90.0
90.2 - 90.0
155.2 - Cut Length
T-Bar
1 @ 29.2 90/90

Frame Calcs
34.4 - 90.0
168.4 - 90.0
195.0 - Cut Length
x2
+ 10 Add On

REV	1	2/27/18	RS	ECN	UPDATED CALCS AS PER PRODUCTION
					DESCRIPTION

REVISIONS

THE INFORMATION CONTAINED IN THIS DRAWING CONSTITUTES THE INTELLECTUAL PROPERTY, INCLUDING, BUT NOT LIMITED TO, KNOWLEDGE, TRADE SECRETS, AND PROPRIETARY INFORMATION WHICH IS THE EXCLUSIVE PROPERTY OF ADVANTEC MANUFACTURING. ALL INFORMATION CONTAINED IN THIS DRAWING IS TO BE HELD IN THE STRICTEST CONFIDENCE BY THE RECIPIENT, AND IS NOT TO BE COPIED, DISCLOSED TO, OR TRANSMITTED TO ANY THIRD PARTIES WITHOUT THE EXPRESS WRITTEN AUTHORIZATION OF ADVANTEC MANUFACTURING.

UNLESS OTHERWISE SPECIFIED DIMENSIONS IN INCHES TOLERANCES Frame Heel +0/-1/4"	REF NO:		<p>26995 GLOUCESTER WAY, LANGLEY, B.C CANADA 1-800-770-0455 FAX 604-607-9992 WWW.ADVANTECGLOBAL.COM</p>		
	DRAWN:	MT			
	DATE:	02/19/18			
	APPROVAL:				
SURFACE FINISH	SHEET:	PROJECT NO.:	DWG. NO.:	QTY.:	REV.:
3rd ANGLE PROJ.	SCALE:	OR1374	C-000560	1	1