

**CT2000 11to16ft ASSEMBLY
SQUARE BASE MOUNTING OPTION**

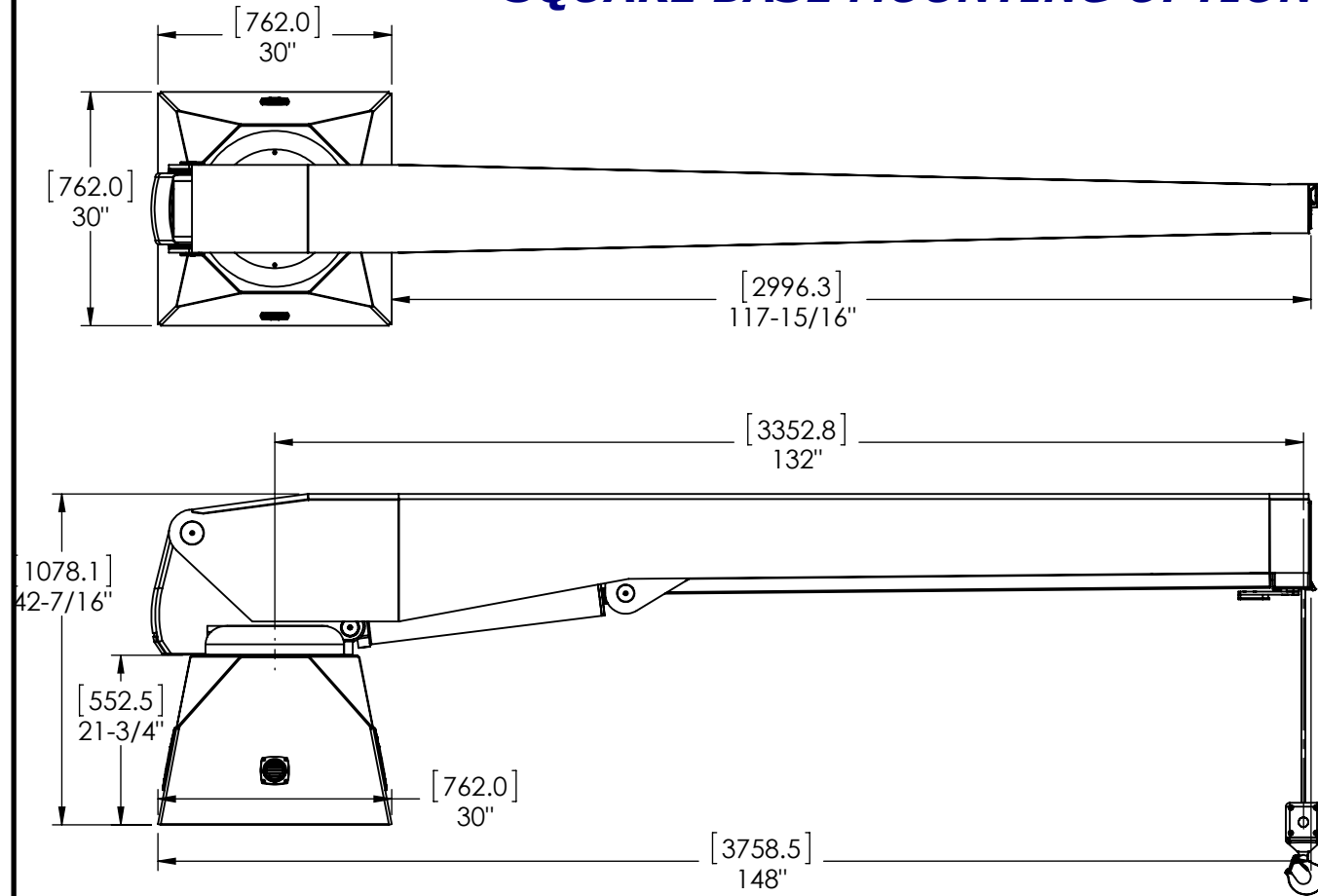

**CT2000 11to16ft ASSEMBLY
ROUND BASE MOUNTING OPTION**

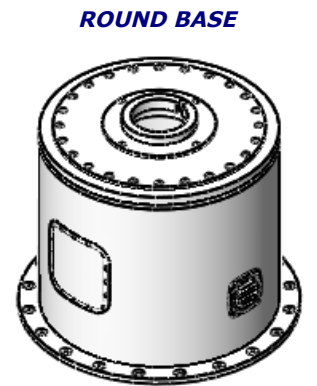
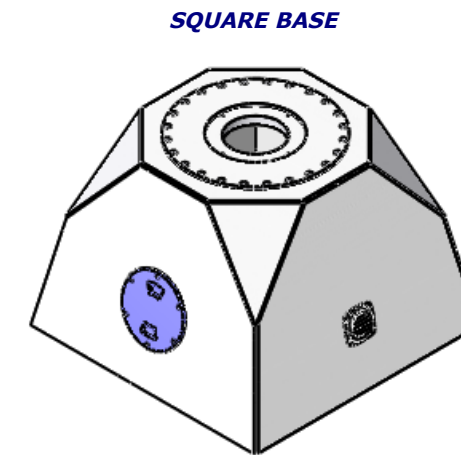
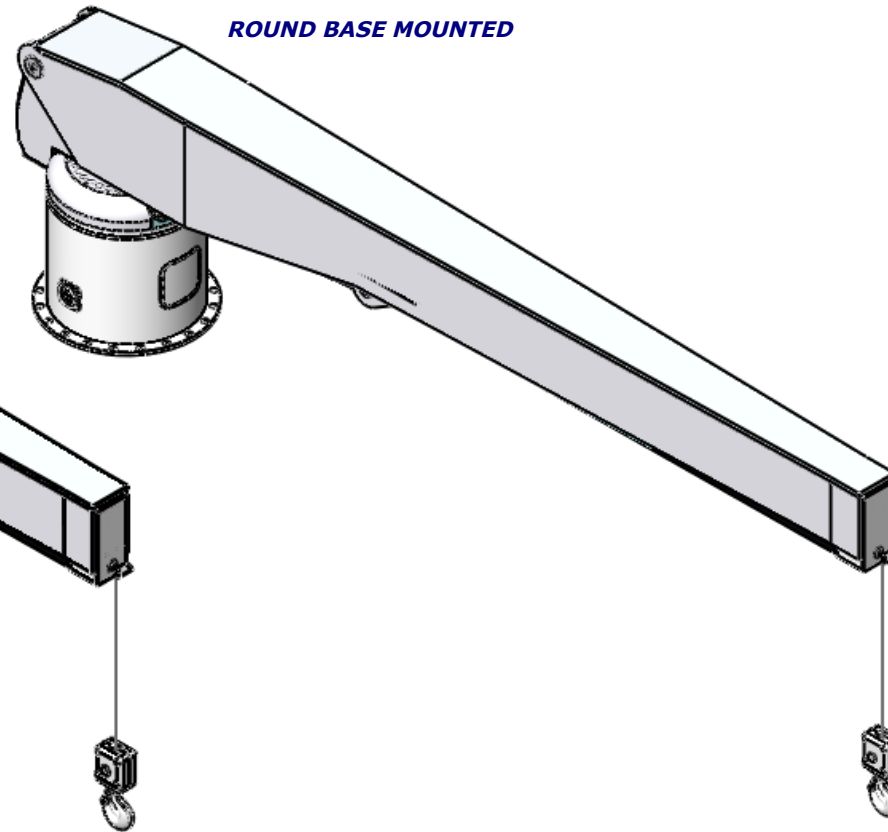
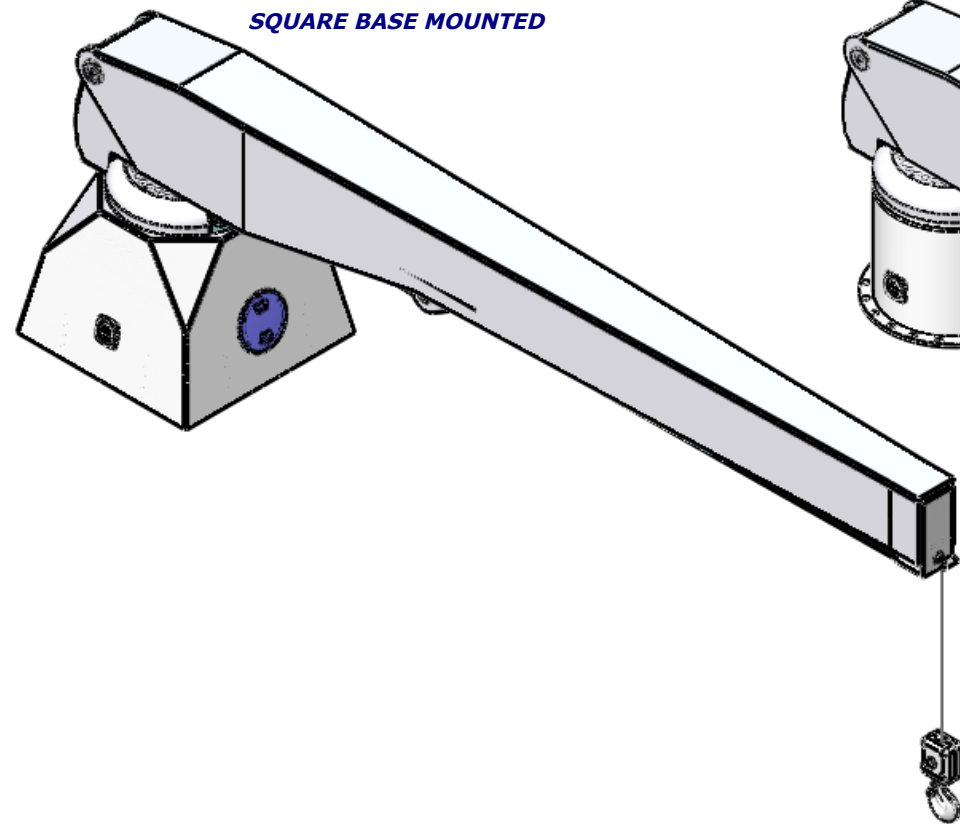
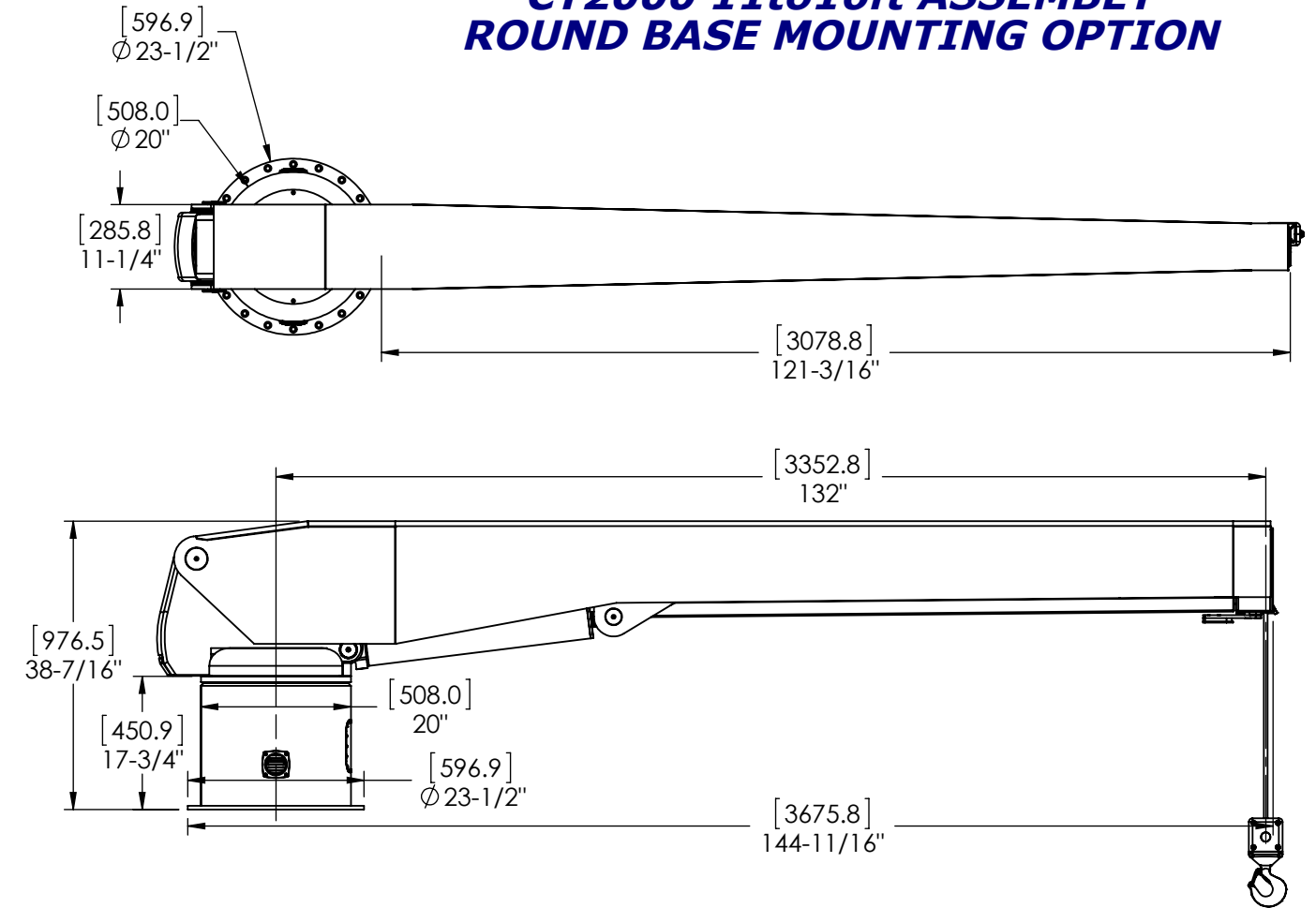

THE INFORMATION CONTAINED IN THIS DRAWING CONSTITUTES THE INTELLECTUAL PROPERTY, INCLUDING, BUT NOT LIMITED TO, KNOWLEDGE, TRADE SECRETS, AND PROPRIETARY INFORMATION WHICH IS THE EXCLUSIVE PROPERTY OF STEELHEAD MARINE LTD.. ALL INFORMATION CONTAINED IN THIS DRAWING IS TO BE HELD IN THE STRICTEST CONFIDENCE BY THE RECIPIENT, AND IS NOT TO BE COPIED, DISCLOSED TO, OR TRANSMITTED TO ANY THIRD PARTIES WITHOUT THE EXPRESS WRITTEN AUTHORIZATION OF STEELHEAD MARINE LTD.

**CAD GENERATED DRAWING.
DO NOT MANUALLY UPDATE.
*** DO NOT SCALE ***
UNLESS OTHERWISE SPECIFIED
ALL DIMENSIONS ARE IN
INCHES.**

TOLERANCES:
FRACTIONS = ±1/16
0, 0.0 = ±0.030
0.00 = ±0.010
0.000 = ±0.005
ANGLES = ±1.0

3rd ANGLE PROJ.



Unit# 2 - 5367 271 Street, Langley, B.C. Canada
Tel: 604-607-0091 Fax: 604-607-0092
Web: www.steelheadmarine.net
E-mail: sales@steelheadmarine.net

DRAWN:	G.B.
DATE:	6/11/2014
CHECKED:	
APPROVED:	
SCALE:	1:24

**CT2000 11to16ft ASSEMBLY
MOUNTED ON MULTIPLE BASES
PROJECT: CT2000**

DWG. NO.:	SHEET:	REV.:
CT2000 11to16ft On Bases	OF 1	